

Mandrinado en desbaste

	Concepto de herramienta	Gama de diámetros, mm	Tolerancia de agujero	Filos de corte	Operación	Elección de plaquitas	Adaptador del lado de la máquina	Página
	Convencional	32-170	IT9	1	- Mandrinado a tracción de un solo filo	- CoroTurn® 107	- Coromant Capto® - Coromant EH	K4-K5
	Convencional	23-150	IT9	2	- Mandrinado a tracción de un solo filo - Mandrinado - Mandrinado escalonado - Mandrinado de un solo filo	- CoroTurn® 107 - T-Max® P - CoroBore® 111	- Coromant Capto® - Coromant EH	K6-K10
	Antivibratorio	23-150	IT9	2	- Mandrinado - Mandrinado escalonado - Mandrinado de un solo filo	- CoroTurn® 107 - CoroBore® 111	- Coromant Capto®	K14
	Convencional	35-214	IT9	3	- Mandrinado - Mandrinado escalonado - Mandrinado de un solo filo	- CoroTurn® 107 - T-Max® P - CoroBore® 111	- Coromant Capto®	K17-K21
Mandrinado de cavidades 	Convencional	85-205	IT9	4,6,8	- Mandrinado - Mandrinado escalonado	- CoroTurn® 107* - CoroBore® 111	- Coromant Capto®	K22
	Convencional	148-300 (350**) 298-1260	IT9	2	- Mandrinado - Mandrinado escalonado - Mandrinado de un solo filo	- CoroTurn® 107 - T-Max® P - CoroBore® 111	- Coromant Capto® - 40X con círculo de 4 pernos	K24-K25 K28-K31
	Peso ligero	148-300	IT9	2	- Mandrinado - Mandrinado escalonado - Mandrinado de un solo filo	- CoroTurn® 107 - CoroBore® 111	- 40S con círculo de 4 pernos	K26
	Antivibratorio	148-300	IT9	2	- Mandrinado - Mandrinado escalonado - Mandrinado de un solo filo	- CoroTurn® 107 - CoroBore® 111	- Adaptador antivibratorio A33	K27

*No incluidos en el kit, los componentes deben pedirse por separado.

**Los componentes deben pedirse por separado.

MANDRINADO Mandrinado en desbaste

CoroBore® BR10

Herramientas de mandrinado a tracción de un solo filo

Aplicación

- Mandrinado en desbaste
- Mandrinado a tracción

Área de aplicación ISO:



Ventajas y características

- Escala de marcado láser en el adaptador para una mayor facilidad de uso a la hora de reglar el diámetro
- Puede montarse cómodamente como una herramienta de mandrinar de dos filos mediante correderas BR20
- Boquillas de refrigerante con capacidad de gran precisión en la corredera para una orientación exacta del refrigerante
- Refrigerante a través de la herramienta para una buena evacuación de la viruta
- Modularidad con Coromant Capto® y Coromant EH

www.sandvik.coromant.com/coroborebr10

Herramientas

Acoplamientos:

- Coromant Capto®
- Coromant EH

Plaquitas

- Plaquitas CoroTurn® 107 estándar con una amplia selección de calidades y geometrías para todo tipo de materiales.

La herramienta de mandrinado a tracción se basa en el adaptador CoroBore® BR20 y una exclusiva corredera y cubierta de mandrinado a tracción.



Disponible como kit de mandrinado a tracción completo o corredera y cubierta de mandrinado a tracción independientes como artículos complementarios.



K 4

Herramienta de mandrinado en desbaste CoroBore® BR10 para mandrinado a tracción

Coromant EH - Suministro de refrigerante interior

KAPR 90°

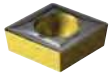

- CCMT, CCGT
CCGX, CCET
- CCMW

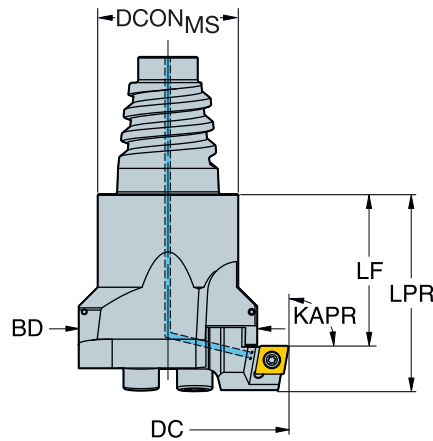

											Dimensiones, mm					
DCN	DCX		CZC _{MS}	CNSC	Código de pedido	DCON _{MS}	ADJLX _{RDL}	LF	LPR	BD ₁			CICT	MIID		
32.00	38.00	06	E20	1	BR10-38CC06F-EH20	19.30	3.00	15.00	25.00	20.00	70	0.070	1	CCMT 06 02 04		
37.00	45.00	06	E25	1	BR10-45CC06F-EH25	24.20	4.00	14.00	24.00	24.00	70	0.110	1	CCMT 06 02 04		

Coromant Capto® - Suministro de refrigerante interior

KAPR 90°

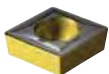

- CCMT, CCGT
CCGX, CCET
- CCMW

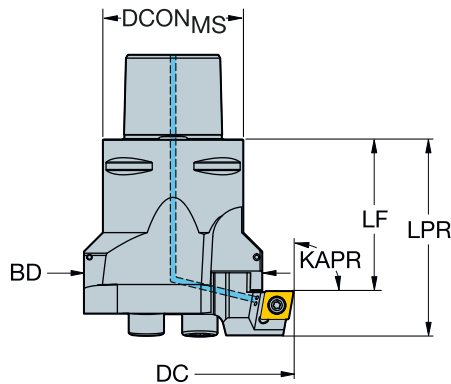

											Dimensiones, mm					
DCN	DCX		CZC _{MS}	CNSC	Código de pedido	DCON _{MS}	ADJLX _{RDL}	LF	LPR	BD ₁			CICT	MIID		
44.00	54.00	06	C3	3	BR10-54CC06F-C3	32.00	5.00	35.00	45.00	30.00	70	0.560	1	CCMT 06 02 04		
53.00	65.00	06	C4	3	BR10-65CC06F-C4	40.00	6.00	43.00	53.00	39.00	70	0.560	1	CCMT 06 02 04		
64.00	76.00	09	C4	3	BR10-76CC09F-C4	40.00	6.00	43.00	58.00	39.00	70	0.560	1	CCMT 09 T3 08		
75.00	91.00	12	C5	3	BR10-91CC12F-C5	50.00	8.00	48.00	68.00	50.00	70	0.860	1	CCMT 12 04 08		
90.00	110.00	12	C5	3	BR10-110CC12F-C5	50.00	10.00	50.00	70.00	63.00	70	1.230	1	CCMT 12 04 08		
109.00	136.00	12	C6	3	BR10-136CC12F-C6	63.00	13.50	68.00	88.00	82.00	70	2.080	1	CCMT 12 04 08		
135.00	170.00	12	C6	3	BR10-170CC12F-C6	63.00	17.50	78.00	98.00	108.00	70	2.380	1	CCMT 12 04 08		

Para obtener información sobre componentes, accesorios y piezas de repuesto para herramientas de mandrinar, visite www.sandvik.coromant.com/es
Para obtener más información sobre plaquitas, consulte el Catálogo de herramientas de torneado



MANDRINADO Mandrinado en desbaste

CoroBore® BR20

Herramientas gemelas de mandrinado en desbaste flexible

Aplicación

- Mandrinado en desbaste
- Mandrinado de doble filo
- Mandrinado escalonado
- Mandrinado a tracción
- Mandrinado de un solo filo

Área de aplicación ISO:



Ventajas y características

- Escala de marcado láser en el adaptador para una mayor facilidad de uso a la hora de reglar el diámetro
- Posibilidad de montaje simplificado como herramienta de mandrinado a tracción, con una corredera o cubierta exclusiva
- Función de mandrinado escalonado integrada sin necesidad de placa de apoyo adicional
- Paso diferencial que reduce la tendencia a la vibración; por lo que las herramientas pueden usarse con voladizos y profundidades de corte más grandes
- Plaquetas de cuatro filos específicas con calidades optimizadas para mandrinado en desbaste.
- Boquillas de refrigerante con capacidad de gran precisión en la corredera para una orientación exacta del refrigerante
- Refrigerante a través de la herramienta para una buena evacuación de la viruta
- También disponible en la gama de herramientas de mandrinado antivibratorias

www.sandvik.coromant.com/coroborebr20

Herramientas

Acoplamientos:

- Coromant Capto®
- Coromant EH

Plaquetas

Plaquetas estándar con calidades y geometrías específicas para todo

- tipo de material
- CoroBore® 111
- CoroTurn® 107

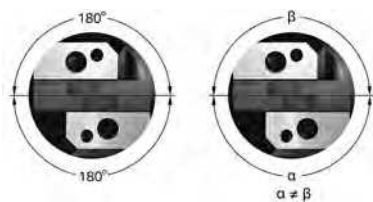

El paso diferencial reduce la tendencia a la vibración; por lo que las herramientas pueden usarse con voladizos y profundidades de corte más grandes.



Plaquetas de mandrinado en desbaste CoroBore® 111 específicas. Con una excelente rotura de la viruta y mayor duración.



Resuelve todos los problemas derivados de trabajar con voladizos largos. Utilizar Silent Tools™ le permite duplicar la profundidad de corte y disfrutar de un mandrinado productivo.

K 6

Herramienta gemela de mandrinado en desbaste CoroBore® BR20

Coromant EH - Suministro de refrigerante interior

KAPR

90°

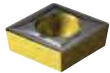

- CCMT, CCGT
CCGX, CCET
- CCMW

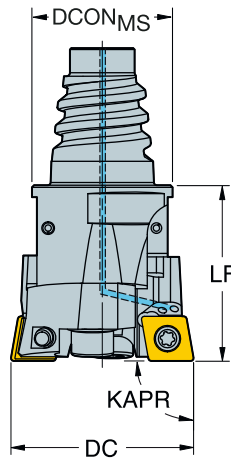

					Dimensiones, mm							
DCN	DCX		CZC _{MS}	CNSC	Código de pedido	DCON _{MS}	ADJLX _{RDL}	LF	BAR	KG	CICT	MIID
23.00	29.00	06	E20	1	BR20-29CC06F-EH20	19.30	3.00	25.00	70	0.070	2	CCMT 06 02 04
28.00	36.00	06	E25	1	BR20-36CC06F-EH25	24.20	4.00	25.00	70	0.110	2	CCMT 06 02 04

Para obtener información sobre componentes, accesorios y piezas de repuesto para herramientas de mandrinar, visite www.sandvik.coromant.com/es
Para obtener más información sobre plaquitas, consulte el Catálogo de herramientas de torneado



MANDRINADO Mandrinado en desbaste

Herramienta gemela de mandrinado en desbaste CoroBore® BR20

Coromant Capto® - Suministro de refrigerante interior



CCMT, CCGT
 CCGX, CCET
 CCMW

KAPR
DSGN

90°
1

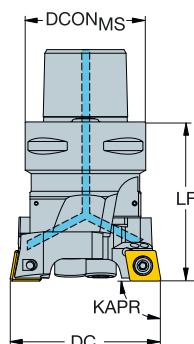

90°
2

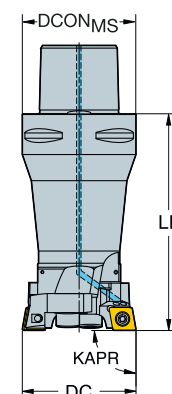

K

							Dimensiones, mm										
DCN	DCX		CZC _{MS}	CNSC	DSGN	Código de pedido	DCON _{MS}	ADJLX _{PDL}	ULDR	LF	BD ₁			CICT	MIID		
23.00	29.00	06	C3	3	2	BR20-29CC06F-C3	32.00	3.00	2.00	76.00	20.00	70	0.260	2	CCMT 06 02 04		
28.00	36.00	06	C3	3	2	BR20-36CC06F-C3	32.00	4.00	2.00	83.00	24.00	70	0.360	2	CCMT 06 02 04		
35.00	45.00	09	C3	3	1	BR20-45CC09F-C3	32.00	5.00		48.00	70	0.270	2	CCMT 09 T3 08			
35.00	45.00	09	C4	3	2	BR20-45CC09F-C4	40.00	5.00	1.50	83.00	30.00	70	0.560	2	CCMT 09 T3 08		
44.00	56.00	09	C4	3	1	BR20-56CC09F-C4	40.00	6.00		56.00	70	0.480	2	CCMT 09 T3 08			
44.00	56.00	09	C5	3	2	BR20-56CC09F-C5	50.00	6.00	1.50	98.00	39.00	70	1.030	2	CCMT 09 T3 08		
55.00	71.00	12	C5	3	1	BR20-71CC12F-C5	50.00	8.00		66.00	70	0.860	2	CCMT 12 04 08			
55.00	71.00	12	C6	3	2	BR20-71CC12F-C6	63.00	8.00	1.50	120.00	50.00	70	1.940	2	CCMT 12 04 08		
70.00	90.00	12	C5	3	1	BR20-90CC12F-C5	50.00	10.00		70.00	70	1.230	2	CCMT 12 04 08			
70.00	90.00	12	C6	3	1	BR20-90CC12F-C6	63.00	10.00		78.00	70	1.580	2	CCMT 12 04 08			
89.00	116.00	12	C6	3	1	BR20-116CC12F-C6	63.00	13.50		90.00	70	2.080	2	CCMT 12 04 08			
89.00	116.00	12	C8	3	1	BR20-116CC12F-C8	80.00	13.50		94.00	70	2.990	2	CCMT 12 04 08			
115.00	150.00	12	C6	3	1	BR20-150CC12F-C6	63.00	17.50		90.00	70	2.380	2	CCMT 12 04 08			
115.00	150.00	12	C8	3	1	BR20-150CC12F-C8	80.00	17.50		100.00	70	3.630	2	CCMT 12 04 08			

Para obtener información sobre componentes, accesorios y piezas de repuesto para herramientas de mandrinar, visite www.sandvik.coromant.com/es

Para obtener más información sobre plaquitas, consulte el Catálogo de herramientas de torneado

Para todas las DSGN 2; LU = DC*ULDR

M

N



L2



M1



N23



N15



K85

K 8



Herramienta gemela de mandrinado en desbaste CoroBore® BR20

Coromant EH - Suministro de refrigerante interior

KAPR

90°

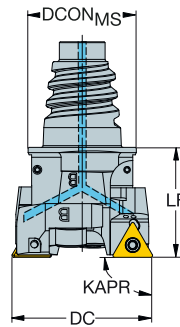

- TCMT, TCMX, TCGT, TCGX, TCEX
- TCMW

					Dimensiones, mm							
DCN	DCX		CZC _{MS}	CNSC	Código de pedido	DCN _{MS}	ADJLX _{RDL}	LF			CICT	MIID
28.00	36.00	09	E25	1	BR20-36TC09F-EH25	24.20	4.00	25.00	70	0.130	2	TCMT 09 02 04

Para obtener información sobre componentes, accesorios y piezas de repuesto para herramientas de mandrinar, visite www.sandvik.coromant.com/es
 Para obtener más información sobre plaquitas, consulte el Catálogo de herramientas de torneado



MANDRINADO Mandrinado en desbaste

Herramienta gemela de mandrinado en desbaste CoroBore® BR20

Coromant Capto® - Suministro de refrigerante interior

KAPR
DSGN

90°
1

90°
2

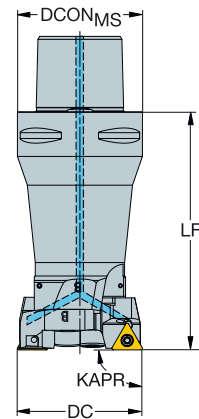
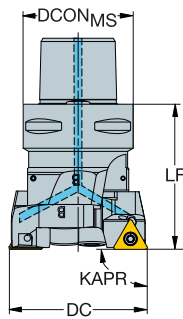

- TCMT, TCMX, TCGT, TCGX, TCEX
- TCMW

										Dimensiones, mm							
DCN	DCX		CZC _{MS}	CNSC	DSGN	Código de pedido	DCON _{MS}	ADJLX _{PDL}	ULDR	LF	BD ₁			CICT	MIID		
28.00	36.00	09	C3	3	2	BR20-36TC09F-C3	32.00	4.00	2.00	83.00	24.00	70	0.380	2	TCMT 09 02 04		
35.00	45.00	11	C3	3	1	BR20-45TC11F-C3	32.00	5.00		48.00		70	0.270	2	TCMT 11 03 04		
44.00	56.00	11	C4	3	1	BR20-56TC11F-C4	40.00	6.00		56.00		70	0.500	2	TCMT 11 03 04		
55.00	71.00	16	C5	3	1	BR20-71TC16F-C5	50.00	8.00		66.00		70	0.860	2	TCMT 16 T3 08		
70.00	90.00	16	C5	3	1	BR20-90TC16F-C5	50.00	10.00		70.00		70	1.250	2	TCMT 16 T3 08		
70.00	90.00	16	C6	3	1	BR20-90TC16F-C6	63.00	10.00		78.00		70	1.600	2	TCMT 16 T3 08		
89.00	116.00	16	C6	3	1	BR20-116TC16F-C6	63.00	13.50		90.00		70	2.100	2	TCMT 16 T3 08		
115.00	150.00	16	C8	3	1	BR20-150TC16F-C8	80.00	17.50		100.00		70	3.650	2	TCMT 16 T3 08		

Para obtener información sobre componentes, accesorios y piezas de repuesto para herramientas de mandrinar, visite www.sandvik.coromant.com/es

Para obtener más información sobre plaquitas, consulte el Catálogo de herramientas de torneado

Para todas las DSGN 2; LU = DC*ULDR



K 10



Herramienta gemela de mandrinado en desbaste CoroBore® BR20

Coromant Capto® - Suministro de refrigerante interior

KAPR 90°



CNMU

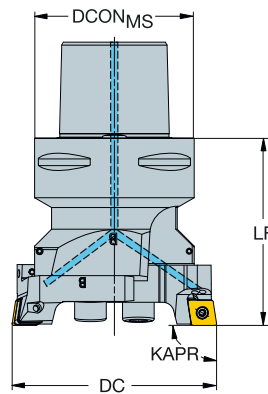

					Dimensiones, mm							
DCN	DCX	CZC _{MS}	CNSC	Código de pedido	DCON _{MS}	ADJLX _{RDL}	LF	BAR	KG	CICT	MIID	
70.00	90.00	12	C6	BR20-90CN12F-C6	63.00	10.00	78.00	70	2.200	2	CNMU 12 04 12	
89.00	116.00	12	C8	BR20-116CN12F-C8	80.00	13.50	94.00	70	2.900	2	CNMU 12 04 12	
115.00	150.00	12	C8	BR20-150CN12F-C8	80.00	17.50	100.00	70	3.690	2	CNMU 12 04 12	

Para obtener información sobre componentes, accesorios y piezas de repuesto para herramientas de mandrinar, visite www.sandvik.coromant.com/es
Para obtener más información sobre plaquitas, consulte el Catálogo de herramientas de torneado



MANDRINADO Mandrinado en desbaste

Herramienta gemela de mandrinado en desbaste CoroBore® BR20

Coromant EH - Suministro de refrigerante interior

KAPR

84°



SPMT

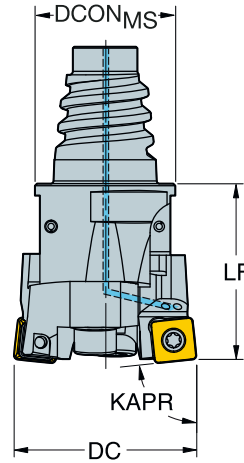

K

Dimensiones, mm

DCN	DCX	CZC _{MS}	CNSC	Código de pedido	DCON _{MS}	ADJLX _{ROL}	LF	BAR	KG	CICT	MIID
23.00	29.00	06	E20	BR20-29SP06Y-EH20	19.30	3.00	25.00	70	0.070	2	SPMT 0606-BM
28.00	36.00	06	E25	BR20-36SP06Y-EH25	24.20	4.00	25.00	70	0.110	2	SPMT 0606-BM

Para obtener información sobre componentes, accesorios y piezas de repuesto para herramientas de mandrinar, visite www.sandvik.coromant.com/es

L

M

N



K 12



Herramienta gemela de mandrinado en desbaste CoroBore® BR20

Coromant Capto® - Suministro de refrigerante interior

KAPR
DSGN

84°
1

84°
2



SPMT

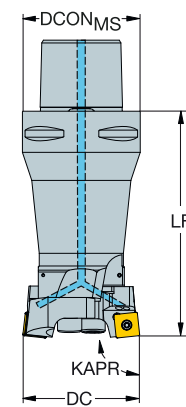
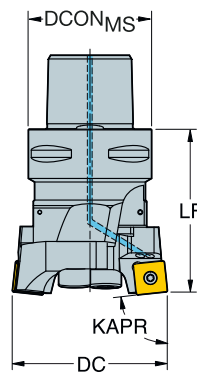

		Dimensiones, mm													
DCN	DCX		CZC _{MS}	CNSC	DSGN	Código de pedido	DCON _{MS}	ADJL _{RDL}	ULDR	LF	BD ₁			CICT	MIID
23.00	29.00	06	C3	3	2	BR20-29SP06Y-C3	32.00	3.00	2.00	76.00	20.00	70	0.260	2	SPMT 0606-BM
28.00	36.00	06	C3	3	2	BR20-36SP06Y-C3	32.00	4.00	2.00	83.00	24.00	70	0.360	2	SPMT 0606-BM
35.00	45.00	08	C3	3	1	BR20-45SP08Y-C3	32.00	5.00		48.00		70	0.270	2	SPMT 0808-BM
35.00	45.00	08	C4	3	2	BR20-45SP08Y-C4	40.00	5.00	1.50	83.00	30.00	70	0.560	2	SPMT 0808-BM
44.00	56.00	08	C4	3	1	BR20-56SP08Y-C4	40.00	6.00		56.00		70	0.480	2	SPMT 0808-BM
44.00	56.00	08	C5	3	2	BR20-56SP08Y-C5	50.00	6.00	1.50	98.00	39.00	70	1.030	2	SPMT 0808-BM
55.00	71.00	12	C5	3	1	BR20-71SP12Y-C5	50.00	8.00		66.00		70	0.860	2	SPMT 1210-BM
55.00	71.00	12	C6	3	2	BR20-71SP12Y-C6	63.00	8.00	1.50	120.00	50.00	70	1.940	2	SPMT 1210-BM
70.00	90.00	12	C5	3	1	BR20-90SP12Y-C5	50.00	10.00		70.00		70	1.230	2	SPMT 1210-BM
70.00	90.00	12	C6	3	1	BR20-90SP12Y-C6	63.00	10.00		78.00		70	1.580	2	SPMT 1210-BM
89.00	116.00	12	C6	3	1	BR20-116SP12Y-C6	63.00	13.50		90.00		70	2.080	2	SPMT 1210-BM
89.00	116.00	12	C8	3	1	BR20-116SP12Y-C8	80.00	13.50		94.00		70	2.990	2	SPMT 1210-BM
115.00	150.00	12	C6	3	1	BR20-150SP12Y-C6	63.00	17.50		90.00		70	2.380	2	SPMT 1210-BM
115.00	150.00	12	C8	3	1	BR20-150SP12Y-C8	80.00	17.50		100.00		70	3.630	2	SPMT 1210-BM

Para obtener información sobre componentes, accesorios y piezas de repuesto para herramientas de mandrinado, visite www.sandvik.coromant.com/es

Para todas las DSGN 2; LU = DC*ULDR



K32



L2



M1



N23



N15



K85



MANDRINADO Mandrinado en desbaste

Herramienta gemela antivibratoria de mandrinado en desbaste CoroBore® BR20

Coromant Capto® - Suministro de refrigerante interior

KAPR
DSGN

90°
1

90°
2

●●● SilentTools®

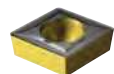

CCMT, CCGT
CCGX, CCET
CCMW

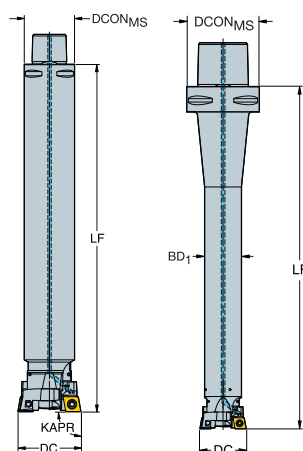

Dimensiones, mm

DCN	DCX		CZC _{MS}	CNSC	DSGN	Código de pedido	DCON _{MS}	ADJLX _{PDL}	ULDR	LF	BD ₁			CICT	MIID
23.00	29.00	06	C4	3	2	BR20D-29CC06F-C4L	40.00	3.00	6.00	199.00	20.00	70	0.740	2	CCMT 06 02 04
28.00	36.00	06	C3	3	2	BR20D-36CC06F-C3L	32.00	4.00	6.00	216.00	25.00	70	1.030	2	CCMT 06 02 04
35.00	45.00	09	C3	3	1	BR20D-45CC09F-C3L	32.00	5.00	6.00	221.00	70	70	1.540	2	CCMT 09 T3 08
35.00	45.00	09	C4	3	2	BR20D-45CC09F-C4L	40.00	5.00	6.00	270.00	32.00	70	1.980	2	CCMT 09 T3 08
35.00	45.00	09	C6	3	2	BR20D-45CC09F-C6L	63.00	5.00	6.00	297.00	32.00	70	2.620	2	CCMT 09 T3 08
44.00	56.00	09	C4	3	1	BR20D-56CC09F-C4L	40.00	6.00	6.00	220.00	70	70	2.380	2	CCMT 09 T3 08
44.00	56.00	09	C5	3	2	BR20D-56CC09F-C5L	50.00	6.00	6.00	336.00	40.00	70	3.720	2	CCMT 09 T3 08
44.00	56.00	09	C6	3	2	BR20D-56CC09F-C6L	63.00	6.00	6.00	363.00	40.00	70	4.350	2	CCMT 09 T3 08
55.00	71.00	12	C5	3	1	BR20D-71CC12F-C5M	50.00	8.00	5.60	300.00	70	70	5.080	2	CCMT 12 04 08
55.00	71.00	12	C6	3	2	BR20D-71CC12F-C6M	63.00	8.00	5.60	400.00	50.00	70	6.940	2	CCMT 12 04 08
70.00	90.00	12	C6	3	1	BR20D-90CC12F-C6M	63.00	10.00	5.60	400.00	70	70	9.910	2	CCMT 12 04 08
70.00	90.00	12	C8	3	2	BR20D-90CC12F-C8M	80.00	10.00	5.60	500.00	63.00	70	12.660	2	CCMT 12 04 08
89.00	116.00	12	C8	3	1	BR20D-116CC12F-C8M	80.00	13.50	5.60	500.00	70	70	18.490	2	CCMT 12 04 08
89.00	116.00	12	C8	3	1	BR20D-116CC12F-C8S	80.00	13.50	5.60	410.00	70	70	16.140	2	CCMT 12 04 08
115.00	150.00	12	C8	3	1	BR20D-150CC12F-C8M	80.00	17.50	5.60	500.00	70	70	18.620	2	CCMT 12 04 08

Para obtener información sobre componentes, accesorios y piezas de repuesto para herramientas de mandrinar, visite www.sandvik.coromant.com/es

Para obtener más información sobre plaquitas, consulte el Catálogo de herramientas de torneado

Para todas las DSGN 2; LU = DC*ULDR



L2



M1



N23



N15



K85

K 14



Herramienta gemela antivibratoria de mandrinado en desbaste CoroBore® BR20

Coromant Capto® - Suministro de refrigerante interior

KAPR
DSGN

90°
1

90°
2

●●● SilentTools®



- TCMT, TCMX, TCGT, TCGX, TCEX
- TCMW

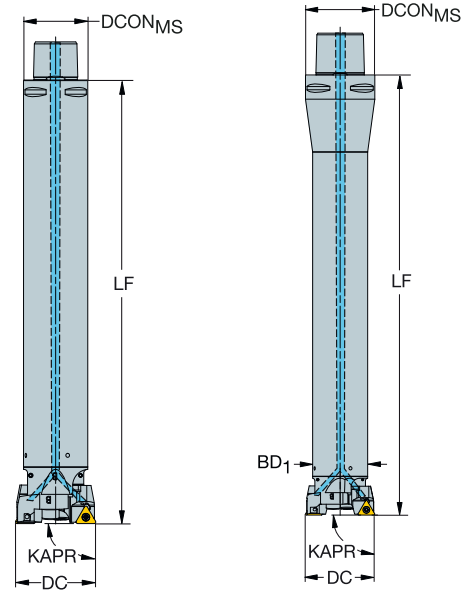

						Dimensiones, mm									
DCN	DCX		CZC _{MS}	CNSC	DSGN	Código de pedido	DCON _{MS}	ADJLX _{RDL}	ULDR	LF	BD ₁			CICT	MIID
28.00	36.00	09	C3	3	2	BR20D-36TC09F-C3L	32.00	4.00	6.00	216.00	25.00	70	1.718	2	TCMT 09 02 04
35.00	45.00	11	C3	3	1	BR20D-45TC11F-C3L	32.00	5.00		221.00		70	2.330	2	TCMT 11 03 04
35.00	45.00	11	C4	3	2	BR20D-45TC11F-C4L	40.00	5.00	6.00	270.00	32.00	70	1.980	2	TCMT 11 03 04
44.00	56.00	11	C4	3	1	BR20D-56TC11F-C4L	40.00	6.00		220.00		70	2.400	2	TCMT 11 03 04
44.00	56.00	11	C5	3	2	BR20D-56TC11F-C5L	50.00	6.00	6.00	336.00	40.00	70	5.740	2	TCMT 11 03 04
55.00	71.00	16	C5	3	1	BR20D-71TC16F-C5M	50.00	8.00		300.00		70	5.080	2	TCMT 16 T3 08
70.00	90.00	16	C6	3	1	BR20D-90TC16F-C6M	63.00	10.00		400.00		70	9.930	2	TCMT 16 T3 08
89.00	116.00	16	C8	3	1	BR20D-116TC16F-C8M	80.00	13.50		500.00		70	22.085	2	TCMT 16 T3 08
89.00	116.00	16	C8	3	1	BR20D-116TC16F-C8S	80.00	13.50		410.00		70	16.160	2	TCMT 16 T3 08
115.00	150.00	16	C8	3	1	BR20D-150TC16F-C8M	80.00	17.50		500.00		70	23.200	2	TCMT 16 T3 08

Para obtener información sobre componentes, accesorios y piezas de repuesto para herramientas de mandrinar, visite www.sandvik.coromant.com/es

Para obtener más información sobre plaquitas, consulte el Catálogo de herramientas de torneado

Para todas las DSGN 2; LU = DC*ULDR



MANDRINADO Mandrinado en desbaste

Herramienta gemela antivibratoria de mandrinado en desbaste CoroBore® BR20

Coromant Capto® - Suministro de refrigerante interior

KAPR
DSGN

84°
1

84°
2

●●● SilentTools®



SPMT

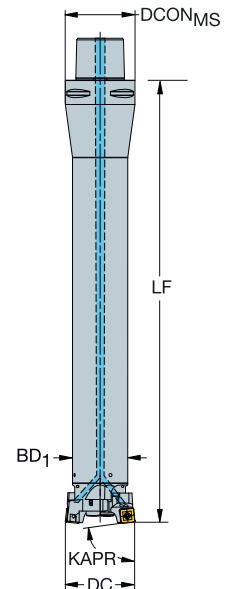
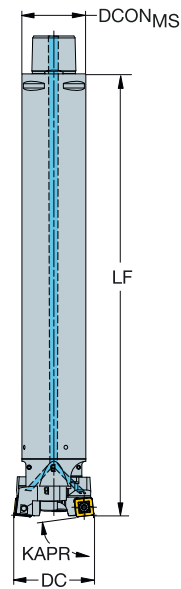

							Dimensiones, mm										
DCN	DCX	CZG _{MS}	CNSC	DSGN	Código de pedido	DCON _{MS}	ADJLX _{RDL}	ULDR	LF	BD ₁	BAR	KG	CICT	MIID			
23.00	29.00	06	C4	3	2	BR20D-29SP06Y-C4L	40.00	3.00	6.00	199.00	20.00	70	0.740	2	SPMT 0606-BM		
28.00	36.00	06	C3	3	2	BR20D-36SP06Y-C3L	32.00	4.00	6.00	216.00	25.00	70	1.030	2	SPMT 0606-BM		
35.00	45.00	08	C3	3	1	BR20D-45SP08Y-C3L	32.00	5.00	6.00	221.00	70	2.330	2	SPMT 0808-BM			
35.00	45.00	08	C4	3	2	BR20D-45SP08Y-C4L	40.00	5.00	6.00	270.00	32.00	70	4.500	2	SPMT 0808-BM		
35.00	45.00	08	C6	3	2	BR20D-45SP08Y-C6L	63.00	5.00	6.00	297.00	32.00	70	2.630	2	SPMT 0808-BM		
44.00	56.00	08	C4	3	1	BR20D-56SP08Y-C4L	40.00	6.00	6.00	220.00	70	5.120	2	SPMT 0808-BM			
44.00	56.00	08	C5	3	2	BR20D-56SP08Y-C5L	50.00	6.00	6.00	336.00	40.00	70	3.720	2	SPMT 0808-BM		
44.00	56.00	08	C6	3	1	BR20D-56SP08Y-C6L	63.00	6.00	6.00	363.00	40.00	70	4.350	2	SPMT 0808-BM		
55.00	71.00	12	C5	3	1	BR20D-71SP12Y-C5M	50.00	8.00	5.60	300.00	70	7.672	2	SPMT 1210-BM			
55.00	71.00	12	C6	3	2	BR20D-71SP12Y-C6M	63.00	8.00	5.60	400.00	50.00	70	6.940	2	SPMT 1210-BM		
70.00	90.00	12	C6	3	1	BR20D-90SP12Y-C6M	63.00	10.00	5.60	400.00	70	12.000	2	SPMT 1210-BM			
70.00	90.00	12	C8	3	2	BR20D-90SP12Y-C8M	80.00	10.00	5.60	500.00	63.00	70	16.183	2	SPMT 1210-BM		
89.00	116.00	12	C8	3	1	BR20D-116SP12Y-C8M	80.00	13.50	5.60	500.00	70	22.125	2	SPMT 1210-BM			
89.00	116.00	12	C8	3	1	BR20D-116SP12Y-C8S	80.00	13.50	5.60	410.00	70	16.140	2	SPMT 1210-BM			
115.00	150.00	12	C8	3	1	BR20D-150SP12Y-C8M	80.00	17.50	5.60	500.00	70	18.620	2	SPMT 1210-BM			

Para obtener información sobre componentes, accesorios y piezas de repuesto para herramientas de mandrinar, visite www.sandvik.coromant.com/es
Para todas las DSGN 2; LU = DC*ULDR



K 16



CoroBore® BR30

Herramientas multifilo de mandrinado en desbaste para una máxima productividad

Aplicación

- Mandrinado en desbaste
- Mandrinado de varios filos
- Mandrinado escalonado
- Mandrinado de un solo filo

Área de aplicación ISO



Ventajas y características

- Herramienta de corte multifilo extremadamente productiva para un máximo volumen de viruta.
- Escala de marcado láser en el adaptador para una mayor facilidad de uso a la hora de reglar el diámetro
- Modularidad con Coromant Capto®
- Refrigerante de alta presión a través del adaptador
- Mandrinado escalonado: disponibilidad de placas de apoyo adicionales; deben pedirse por separado
- Diseño corto, rígido y compacto que proporciona la máxima estabilidad

www.sandvik.coromant.com/coroborebr30

Herramientas

Acoplamientos:

- Coromant Capto®



Plaquitas

Plaquitas estándar con calidades y geometrías específicas para todo tipo de material

- CoroBore® 111
- CoroTurn® 107
- T-max® P

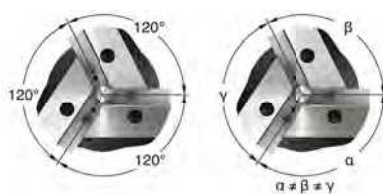

El paso diferencial reduce la tendencia a la vibración; por lo que las herramientas pueden usarse con voladizos y profundidades de corte más grandes.

Desde los 85 hasta los 205 mm de diámetro, CoroBore® BR30 está disponible con hasta 8 filos de corte para garantizar el mayor volumen de viruta posible.

En caso de no disponer de una máquina de pre-reglaje para ajustar el diámetro de CoroBore BR30, mida la distancia del pasador a la plaquita y réstele la mitad del diámetro del pasador. Multiplique esta cifra por dos para obtener el diámetro de mandrinado efectivo.

Plaquitas de mandrinado en desbaste CoroBore® 111 específicas. Con una excelente rotura de la viruta y mayor duración.

MANDRINADO Mandrinado en desbaste

Herramienta de mandrinado en desbaste CoroBore® BR30 de tres filos

Coromant Capto® - Suministro de refrigerante interior



- CCMT, CCGT
- CCGX, CCET
- CCMW

KAPR
DSGN

90°
1

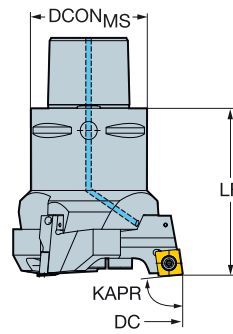

90°
2

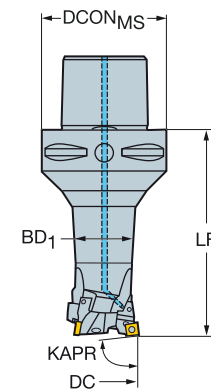

							Dimensiones, mm								
DCN	DCX		CZC _{MS}	CNSC	DSGN	Código de pedido	DCON _{MS}	ADJLX _{RDL}	ULDR	LF	BD ₁			CICT	MIID
35.00	40.50	06	C3	3	1	BR30-41CC06F-C3	32.00	2.75		48.00		70	0.250	3	CCMT 06 02 04
35.00	40.50	06	C4	3	2	BR30-41CC06F-C4	40.00	2.75	1.50	83.00	31.50	70	0.640	3	CCMT 06 02 04
39.50	45.00	06	C3	3	1	BR30-45CC06F-C3	32.00	2.75		48.00		70	0.280	3	CCMT 06 02 04
39.50	45.00	06	C4	3	2	BR30-45CC06F-C4	40.00	2.75	1.50	83.00	31.50	70	0.670	3	CCMT 06 02 04
44.00	50.50	06	C4	3	1	BR30-51CC06F-C4	40.00	3.25		56.00		70	0.620	3	CCMT 06 02 04
44.00	50.50	06	C5	3	2	BR30-51CC06F-C5	50.00	3.25	1.50	98.00	39.60	70	1.180	3	CCMT 06 02 04
49.50	56.00	06	C4	3	1	BR30-56CC06F-C4	40.00	3.25		56.00		70	0.650	3	CCMT 06 02 04
49.50	56.00	09	C4	3	1	BR30-56CC09F-C4	40.00	3.25		58.00		70	0.641	3	CCMT 09 T3 08
49.50	56.00	06	C5	3	2	BR30-56CC06F-C5	50.00	3.25	1.50	98.00	39.60	70	1.210	3	CCMT 06 02 04
49.50	56.00	09	C5	3	2	BR30-56CC09F-C5	50.00	3.25	1.50	100.00	39.60	70	1.240	3	CCMT 09 T3 08
55.00	63.00	09	C5	3	1	BR30-63CC09F-C5	50.00	4.00		66.00		70	0.890	3	CCMT 09 T3 08
55.00	63.00	09	C6	3	2	BR30-63CC09F-C6	63.00	4.00	1.50	120.00	49.50	70	1.980	3	CCMT 09 T3 08
62.00	70.00	09	C5	3	1	BR30-70CC09F-C5	50.00	4.00		66.00		70	0.920	3	CCMT 09 T3 08
62.00	70.00	12	C5	3	1	BR30-70CC12F-C5	50.00	4.00		68.00		70	0.980	3	CCMT 12 04 08
62.00	70.00	09	C6	3	2	BR30-70CC09F-C6	63.00	4.00	1.50	120.00	49.50	70	2.312	3	CCMT 09 T3 08
62.00	70.00	12	C6	3	2	BR30-70CC12F-C6	63.00	4.00	1.50	122.00	49.50	70	2.070	3	CCMT 12 04 08
69.00	78.50	12	C5	3	1	BR30-79CC12F-C5	50.00	4.75		70.00		70	1.180	3	CCMT 12 04 08
69.00	78.50	12	C6	3	1	BR30-79CC12F-C6	63.00	4.75		78.00		70	2.130	3	CCMT 12 04 08
77.50	87.00	12	C5	3	1	BR30-87CC12F-C5	50.00	4.75		70.00		70	1.210	3	CCMT 12 04 08
77.50	87.00	12	C6	3	1	BR30-87CC12F-C6	63.00	4.75		78.00		70	1.967	3	CCMT 12 04 08
86.00	97.00	12	C6	3	1	BR30-97CC12F-C6	63.00	5.50		90.00		70	2.280	3	CCMT 12 04 08
86.00	97.00	12	C8	3	1	BR30-97CC12F-C8	80.00	5.50		94.00		70	3.300	3	CCMT 12 04 08
96.00	107.00	12	C6	3	1	BR30-107CC12F-C6	63.00	5.50		90.00		70	2.340	3	CCMT 12 04 08
96.00	107.00	12	C8	3	1	BR30-107CC12F-C8	80.00	5.50		94.00		70	3.360	3	CCMT 12 04 08
106.00	122.00	12	C8	3	1	BR30-122CC12F-C8	80.00	8.00		100.00		70	4.100	3	CCMT 12 04 08
121.00	137.00	12	C8	3	1	BR30-137CC12F-C8	80.00	8.00		100.00		70	4.250	3	CCMT 12 04 08
136.00	152.00	12	C8	3	1	BR30-152CC12F-C8	80.00	8.00		100.00		70	4.760	3	CCMT 12 04 08
151.00	167.00	12	C8	3	1	BR30-167CC12F-C8	80.00	8.00		100.00		70	4.880	3	CCMT 12 04 08
166.00	191.00	12	C8	3	1	BR30-191CC12F-C8	80.00	12.50		115.00		70	6.860	3	CCMT 12 04 08
189.00	214.00	12	C8	3	1	BR30-214CC12F-C8	80.00	12.50		115.00		70	7.130	3	CCMT 12 04 08

Para obtener información sobre componentes, accesorios y piezas de repuesto para herramientas de mandrinar, visite www.sandvik.coromant.com/es

Para obtener más información sobre plaquitas, consulte el Catálogo de herramientas de torneado

Para todas las DSGN 2; LU = DC*ULDR



L2



M1



N23



N15



K86

K 18



Herramienta de mandrinado en desbaste CoroBore® BR30 de tres filos

Coromant Capto® - Suministro de refrigerante interior

KAPR

90°



- CNMM
- CNMG
- CNMA, CNGA

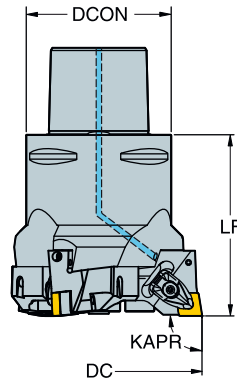

					Dimensiones, mm							
DCN	DCX		CZC _{MS}	CNSC	Código de pedido	DCON _{MS}	ADJLX _{RDL}	LF	BAR	KG	CICT	MIID
106.00	122.00	12	C8	3	BR30-122CN12F-C8	80.00	8.00	100.00	70	4.190	3	CNMG 12 04 08
121.00	137.00	12	C8	3	BR30-137CN12F-C8	80.00	8.00	100.00	70	4.340	3	CNMG 12 04 08
136.00	152.00	12	C8	3	BR30-152CN12F-C8	80.00	8.00	100.00	70	4.820	3	CNMG 12 04 08
151.00	167.00	12	C8	3	BR30-167CN12F-C8	80.00	8.00	100.00	70	4.970	3	CNMG 12 04 08
166.00	191.00	16	C8	3	BR30-191CN16F-C8	80.00	12.50	119.00	70	7.430	3	CNMG 16 06 12
189.00	214.00	16	C8	3	BR30-214CN16F-C8	80.00	12.50	119.00	70	22.400	3	CNMG 16 06 12

Para obtener información sobre componentes, accesorios y piezas de repuesto para herramientas de mandrinar, visite www.sandvik.coromant.com/es
 Para obtener más información sobre plaquitas, consulte el Catálogo de herramientas de torneado



MANDRINADO Mandrinado en desbaste

Herramienta de mandrinado en desbaste CoroBore® BR30 de tres filos

Coromant Capto® - Suministro de refrigerante interior

KAPR

84°

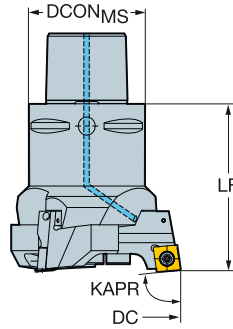

SPMT

					Dimensiones, mm								
DCN	DCX		CXC_MS	CNSC	Código de pedido	DCON_MS	ADJLX_ROL	LF			CICT	MIID	
35.00	40.50	06	C3	3	BR30-41SP06Y-C3	32.00	2.75	48.00	70	0.250	3	SPMT 0606-BM	
39.50	45.00	06	C3	3	BR30-45SP06Y-C3	32.00	2.75	48.00	70	0.280	3	SPMT 0606-BM	
44.00	50.50	06	C4	3	BR30-51SP06Y-C4	40.00	3.25	56.00	70	0.620	3	SPMT 0606-BM	
49.50	56.00	08	C4	3	BR30-56SP08Y-C4	40.00	3.25	58.00	70	0.640	3	SPMT 0808-BM	
55.00	63.00	08	C5	3	BR30-63SP08Y-C5	50.00	4.00	66.00	70	0.890	3	SPMT 0808-BM	
62.00	70.00	12	C5	3	BR30-70SP12Y-C5	50.00	4.00	68.00	70	0.980	3	SPMT 1210-BM	
69.00	78.50	12	C6	3	BR30-79SP12Y-C6	63.00	4.75	78.00	70	1.922	3	SPMT 1210-BM	
77.50	87.00	12	C6	3	BR30-87SP12Y-C6	63.00	4.75	78.00	70	2.190	3	SPMT 1210-BM	
86.00	97.00	12	C8	3	BR30-97SP12Y-C8	80.00	5.50	94.00	70	3.300	3	SPMT 1210-BM	
96.00	107.00	12	C8	3	BR30-107SP12Y-C8	80.00	5.50	94.00	70	3.360	3	SPMT 1210-BM	
106.00	122.00	12	C8	3	BR30-122SP12Y-C8	80.00	8.00	100.00	70	4.100	3	SPMT 1210-BM	
121.00	137.00	12	C8	3	BR30-137SP12Y-C8	80.00	8.00	100.00	70	4.250	3	SPMT 1210-BM	
136.00	152.00	12	C8	3	BR30-152SP12Y-C8	80.00	8.00	100.00	70	4.760	3	SPMT 1210-BM	
151.00	167.00	12	C8	3	BR30-167SP12Y-C8	80.00	8.00	100.00	70	4.880	3	SPMT 1210-BM	
166.00	191.00	12	C8	3	BR30-191SP12Y-C8	80.00	12.50	115.00	70	6.860	3	SPMT 1210-BM	
189.00	214.00	12	C8	3	BR30-214SP12Y-C8	80.00	12.50	115.00	70	7.130	3	SPMT 1210-BM	

Para obtener información sobre componentes, accesorios y piezas de repuesto para herramientas de mandrinar, visite www.sandvik.coromant.com/es



K32



L2



M1



N23



N15



K86

K 20



Herramienta de mandrinado en desbaste CoroBore® BR30 de tres filos

Coromant Capto® - Suministro de refrigerante interior

KAPR

84°

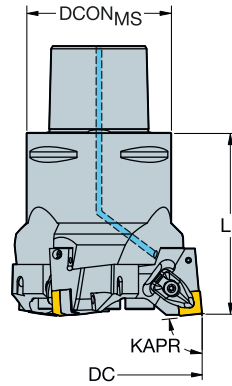

- SNMM
- SNMG
- SNMA, SNGA

					Dimensiones, mm								
DCN	DCX		CZC _{MS}	CNSC	Código de pedido	DCON _{MS}	ADJLX _{RDL}	LF	BAR	KG	CICT	MIID	
106.00	122.00	12	C8	3	BR30-122SN12Y-C8	80.00	8.00	100.00	70	4.190	3	SNMG 12 04 08	
121.00	137.00	12	C8	3	BR30-137SN12Y-C8	80.00	8.00	100.00	70	4.340	3	SNMG 12 04 08	
136.00	152.00	12	C8	3	BR30-152SN12Y-C8	80.00	8.00	100.00	70	4.820	3	SNMG 12 04 08	
151.00	167.00	12	C8	3	BR30-167SN12Y-C8	80.00	8.00	100.00	70	4.970	3	SNMG 12 04 08	
166.00	191.00	15	C8	3	BR30-191SN15Y-C8	80.00	12.50	119.00	70	7.480	3	SNMG 15 06 12	
189.00	214.00	15	C8	3	BR30-214SN15Y-C8	80.00	12.50	119.00	70	7.790	3	SNMG 15 06 12	

Para obtener información sobre componentes, accesorios y piezas de repuesto para herramientas de mandrinar, visite www.sandvik.coromant.com/es
Para obtener más información sobre plaquitas, consulte el Catálogo de herramientas de torneado



MANDRINADO Mandrinado en desbaste

Herramienta multifilo de mandrinado en desbaste CoroBore® BR30

Coromant Capto® - Suministro de refrigerante interior

Específica para operaciones de mandrinado de cavidades

KAPR

84°



SPMT

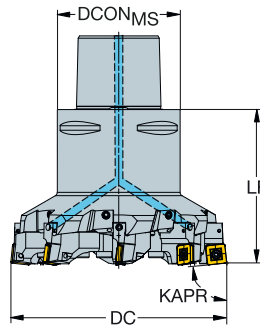

					Dimensiones, mm							
DCN	DCX	CZ _{MS}	CNSC	Código de pedido	DCON _{MS}	ADJLX _{RGL}	LF			CICT	MIID	
85.00	94.50	12	C6	3	BR30-095-4-SP12Y-C6	63.00	4.75	80.00	70	2.050	4	SPMT 1210-BM
93.50	103.00	12	C6	3	BR30-103-4-SP12Y-C6	63.00	4.75	80.00	70	2.130	4	SPMT 1210-BM
102.00	111.50	12	C8	3	BR30-112-6-SP12Y-C8	80.00	4.75	100.00	70	4.110	6	SPMT 1210-BM
110.50	120.00	12	C8	3	BR30-120-6-SP12Y-C8	80.00	4.75	100.00	70	4.230	6	SPMT 1210-BM
119.00	128.50	12	C8	3	BR30-129-8-SP12Y-C8	80.00	4.75	100.00	70	4.510	8	SPMT 1210-BM
127.50	137.00	12	C8	3	BR30-137-8-SP12Y-C8	80.00	4.75	100.00	70	4.670	8	SPMT 1210-BM
136.00	145.50	12	C8	3	BR30-146-8-SP12Y-C8	80.00	4.75	100.00	70	4.900	8	SPMT 1210-BM
144.50	154.00	12	C8	3	BR30-154-8-SP12Y-C8	80.00	4.75	100.00	70	6.300	8	SPMT 1210-BM
153.00	162.50	12	C8	3	BR30-163-6-SP12Y-C8	80.00	4.75	100.00	70	5.150	6	SPMT 1210-BM
161.50	171.00	12	C8	3	BR30-171-6-SP12Y-C8	80.00	4.75	100.00	70	5.270	6	SPMT 1210-BM
170.00	179.50	12	C8	3	BR30-180-6-SP12Y-C8	80.00	4.75	100.00	70	5.730	6	SPMT 1210-BM
178.50	188.00	12	C8	3	BR30-188-6-SP12Y-C8	80.00	4.75	100.00	70	5.850	6	SPMT 1210-BM
187.00	196.50	12	C8	3	BR30-197-6-SP12Y-C8	80.00	4.75	100.00	70	6.470	6	SPMT 1210-BM
195.50	205.00	12	C8	3	BR30-205-6-SP12Y-C8	80.00	4.75	100.00	70	6.590	6	SPMT 1210-BM

Para obtener información sobre componentes, accesorios y piezas de repuesto para herramientas de mandrinar, visite www.sandvik.coromant.com/es



K32



L2



M1



N23



N15



K86

K 22



CoroBore® 820 XL

Herramienta de mandrinado en desbaste para grandes diámetros

Aplicación

- Mandrinado en desbaste
- Mandrinado de doble filo
- Mandrinado escalonado
- Mandrinado de un solo filo

Área de aplicación ISO



Ventajas y características

- Diseño corto, rígido y compacto que proporciona la máxima estabilidad en mandrinado en desbaste de gran diámetro
- Capacidad de ajuste axial y radial
- Refrigerante a través de la herramienta para una buena evacuación de la viruta
- Base modular robusta para la creación de conjuntos en diferentes aplicaciones (mandrinado en desbaste, mandrinado de precisión, ranurado frontal, spiro grooving y torneado con interpolación)

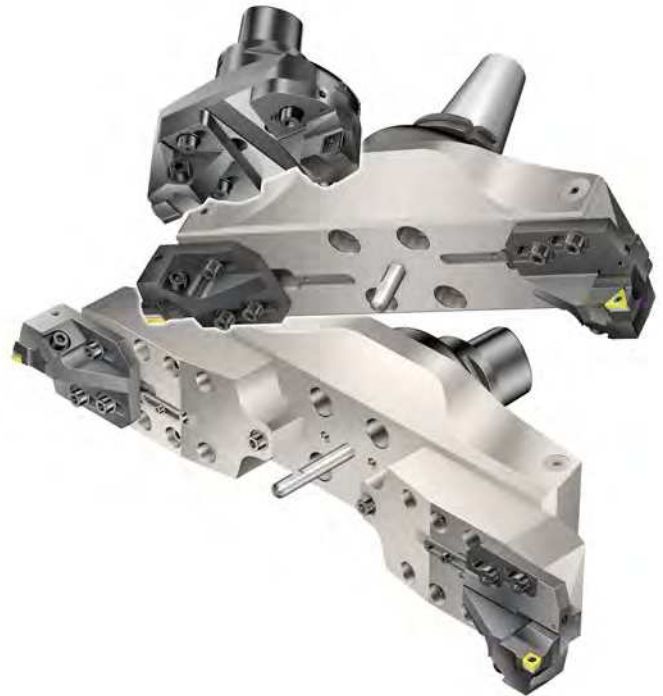

www.sandvik.coromant.com/corobore820

●●●● SilentTools®

Herramientas

Acoplamientos:

- Coromant Capto®
- En eje

Plaquitas

Plaquitas estándar con calidades y geometrías específicas para todo tipo de material

- CoroBore® 111
- CoroTurn® 107
- T-max® P



Para realizar un ajuste radial sencillo de las correderas, apriete ligeramente los tornillos y ajuste el diámetro con la llave. Los cartuchos pueden ajustarse en dirección axial para las operaciones de mandrinado escalonado.



Utilice el mismo puente/extensión de puente para desbaste, acabado y ranurado frontal a partir de 148 mm de diámetro (es necesario utilizar un contrapeso para acabado).



Mandrine diámetros grandes sin aumentar el peso de la herramienta.



Plaquitas de mandrinado en desbaste CoroBore® 111 específicas. Con una excelente rotura de la viruta y mayor duración.

MANDRINADO Mandrinado en desbaste

Herramienta de mandrinado en desbaste CoroBore® 820 XL

Coromant Capto® - Suministro de refrigerante interior



SPMT

KAPR

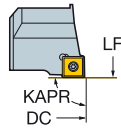

90°

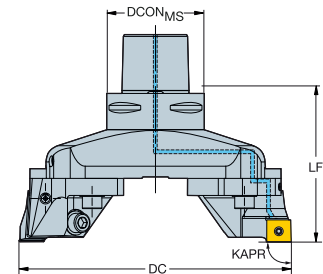
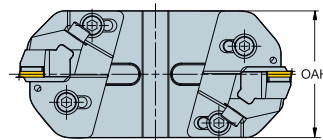

Dimensiones, mm

DCN	DCX		CZC _{MS}	CNSC	Código de pedido	DCON _{MS}	ADJLX _{AVL}	ADJLX _{RDL}	LF	OAH	BAR	KG	CICT	MIID
148.00	200.00	18	C8	3	820-200SP18-C8	80.00	1.50	26.00	122.00	104.00	70	6.900	2	SPMT 1810-BM
148.00	200.00	18	C10	3	820-200SP18-C10	100.00	1.50	26.00	128.00	104.00	70	9.900	2	SPMT 1810-BM
198.00	250.00	18	C8	3	820-250SP18-C8	80.00	1.50	26.00	122.00	104.00	70	8.700	2	SPMT 1810-BM
198.00	250.00	18	C10	3	820-250SP18-C10	100.00	1.50	26.00	128.00	104.00	70	11.308	2	SPMT 1810-BM
248.00	300.00	18	C8	3	820-300SP18-C8	80.00	1.50	26.00	122.00	104.00	70	10.620	2	SPMT 1810-BM
248.00	300.00	18	C10	3	820-300SP18-C10	100.00	1.50	26.00	128.00	104.00	70	12.640	2	SPMT 1810-BM



TCMT, TCMX,
TCGT, TCGX
TCEX
TCMW

KAPR

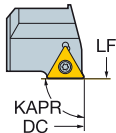

90°

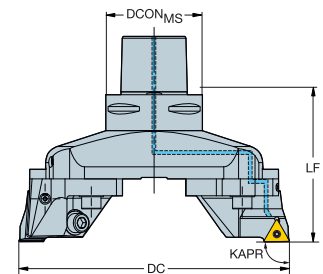
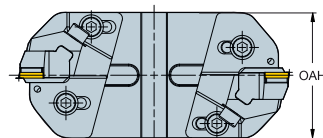

Dimensiones, mm

DCN	DCX		CZC _{MS}	CNSC	Código de pedido	DCON _{MS}	ADJLX _{AVL}	ADJLX _{RDL}	LF	OAH	BAR	KG	CICT	MIID
148.00	200.00	22	C8	3	820-200TC22-C8	80.00	1.50	26.00	122.00	104.00	70	8.390	2	TCMT 22 04 08
148.00	200.00	22	C10	3	820-200TC22-C10	100.00	1.50	26.00	128.00	104.00	70	10.170	2	TCMT 22 04 08
198.00	250.00	22	C8	3	820-250TC22-C8	80.00	1.50	26.00	122.00	104.00	70	8.800	2	TCMT 22 04 08
198.00	250.00	22	C10	3	820-250TC22-C10	100.00	1.50	26.00	128.00	104.00	70	11.400	2	TCMT 22 04 08
248.00	300.00	22	C8	3	820-300TC22-C8	80.00	1.50	26.00	122.00	104.00	70	10.600	2	TCMT 22 04 08
248.00	300.00	22	C10	3	820-300TC22-C10	100.00	1.50	26.00	128.00	104.00	70	12.660	2	TCMT 22 04 08

Para obtener información sobre componentes, accesorios y piezas de repuesto para herramientas de mandrinado, visite www.sandvik.coromant.com/es

Para obtener más información sobre plaquitas, consulte el Catálogo de herramientas de torneado



K32



L2



M1



N23



N15



K87

K 24



Herramienta de mandrinado en desbaste CoroBore® 820 XL

Coromant Capto® - Suministro de refrigerante interior



- CNMM
- CNMG
- CNMA, CNGA

KAPR

90°

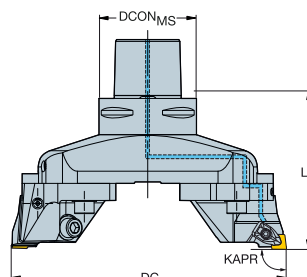
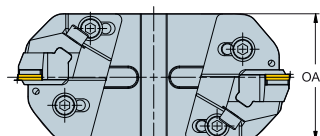
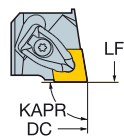

						Dimensiones, mm									
DCN	DCX		CZC _{MS}	CNSC	Código de pedido	DCON _{MS}	ADJLX _{AVL}	ADJLX _{RDL}	LF	OAH	BAR	KG	CICT	MIID	
148.00	200.00	19	C8	3	820-200CN19-C8	80.00	1.50	26.00	122.00	104.00	70	8.240	2	CNMG 19 06 12	
148.00	200.00	19	C10	3	820-200CN19-C10	100.00	1.50	26.00	128.00	104.00	70	10.100	2	CNMG 19 06 12	
198.00	250.00	19	C8	3	820-250CN19-C8	80.00	1.50	26.00	122.00	104.00	70	9.620	2	CNMG 19 06 12	
198.00	250.00	19	C10	3	820-250CN19-C10	100.00	1.50	26.00	128.00	104.00	70	11.520	2	CNMG 19 06 12	
248.00	300.00	19	C8	3	820-300CN19-C8	80.00	1.50	26.00	122.00	104.00	70	10.000	2	CNMG 19 06 12	
248.00	300.00	19	C10	3	820-300CN19-C10	100.00	1.50	26.00	128.00	104.00	70	12.685	2	CNMG 19 06 12	

Para obtener más información sobre plaquitas, consulte el Catálogo de herramientas de torneado



SPMT

KAPR

84°

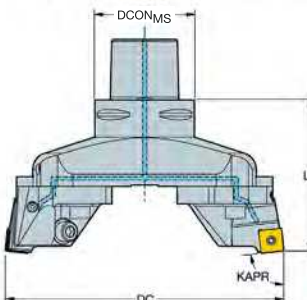
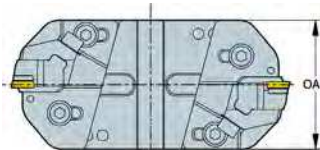
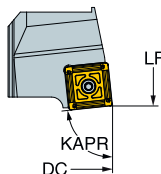

						Dimensiones, mm									
DCN	DCX		CZC _{MS}	CNSC	Código de pedido	DCON _{MS}	ADJLX _{AVL}	ADJLX _{RDL}	LF	OAH	BAR	KG	CICT	MIID	
148.00	200.00	18	C8	3	820-200SP18Y-C8	80.00	1.50	26.00	122.00	104.00	70	7.030	2	SPMT 1810-BM	
148.00	200.00	18	C10	3	820-200SP18Y-C10	100.00	1.50	26.00	128.00	104.00	70	8.940	2	SPMT 1810-BM	
198.00	250.00	18	C8	3	820-250SP18Y-C8	80.00	1.50	26.00	122.00	104.00	70	8.260	2	SPMT 1810-BM	
198.00	250.00	18	C10	3	820-250SP18Y-C10	100.00	1.50	26.00	128.00	104.00	70	10.190	2	SPMT 1810-BM	
248.00	300.00	18	C8	3	820-300SP18Y-C8	80.00	1.50	26.00	122.00	104.00	70	9.460	2	SPMT 1810-BM	
248.00	300.00	18	C10	3	820-300SP18Y-C10	100.00	1.50	26.00	128.00	104.00	70	11.510	2	SPMT 1810-BM	

Para obtener información sobre componentes, accesorios y piezas de repuesto para herramientas de mandrinar, visite www.sandvik.coromant.com/es



K32



L2



M1



N23



N15



K87



MANDRINADO Mandrinado en desbaste

Herramienta de mandrinado en desbaste CoroBore® 820 XL de peso ligero

Eje - Suministro de refrigerante interior

KAPR 90°

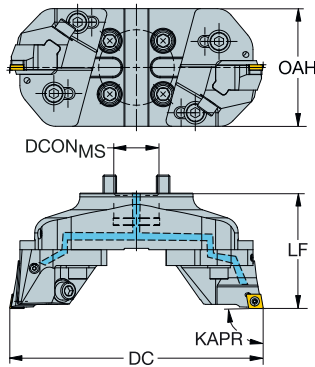

- CCMT, CCGT
CCGX, CCET
- CCMW

SPA

K

Dimensiones, mm

DCN	DCX		CZC _{MS}	CNSC	Código de pedido	DCON _{MS}	ADJLX _{AVL}	ADJLX _{RDL}	LF	OAH	BAR	KG	CICT	MIID
148.00	200.00	12	40S	1	820L-200CC12F	40.00	1.50	26.00	102.00	104.00	70	3.860	2	CCMT 12 04 08
198.00	250.00	12	40S	1	820L-250CC12F	40.00	1.50	26.00	102.00	104.00	70	4.390	2	CCMT 12 04 08
248.00	300.00	12	40S	1	820L-300CC12F	40.00	1.50	26.00	102.00	104.00	70	4.870	2	CCMT 12 04 08

Para obtener más información sobre plaquitas, consulte el Catálogo de herramientas de torneado

KAPR 84°

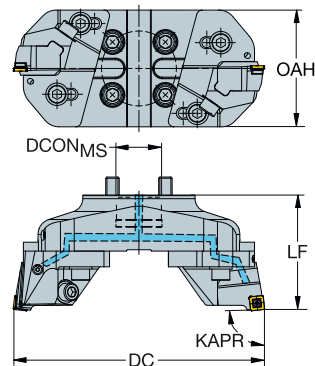

- SPMT

M

Dimensiones, mm

DCN	DCX		CZC _{MS}	CNSC	Código de pedido	DCON _{MS}	ADJLX _{AVL}	ADJLX _{RDL}	LF	OAH	BAR	KG	CICT	MIID
148.00	200.00	12	40S	1	820L-200SP12Y	40.00	1.50	26.00	102.00	104.00	70	3.860	2	SPMT 1210-BM
198.00	250.00	12	40S	1	820L-250SP12Y	40.00	1.50	26.00	102.00	104.00	70	4.390	2	SPMT 1210-BM
248.00	300.00	12	40S	1	820L-300SP12Y	40.00	1.50	26.00	102.00	104.00	70	4.870	2	SPMT 1210-BM

Debe utilizarse con portaherramientas de fresas de planeado 40S, por ejemplo C8-391.05-40 060M. Pedir por separado.

Para obtener información sobre componentes, accesorios y piezas de repuesto para herramientas de mandrinar, visite www.sandvik.coromant.com/es

N



K 26



Herramienta de mandrinado en desbaste CoroBore® 820 XL

Eje - Suministro de refrigerante interior

Específica para mandrinado con Silent Tools

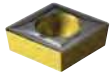

- CCMT, CCGT
CCGX, CCET
- CCMW

KAPR

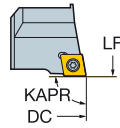

90°

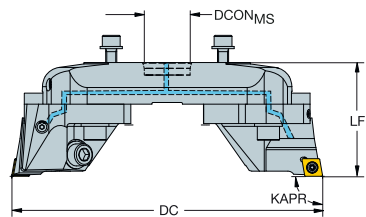
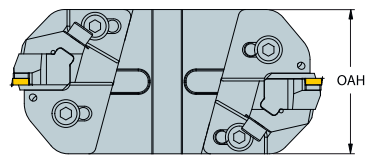

						Dimensiones, mm								
DCN	DCX		CZC _{MS}	CNSC	Código de pedido	DCON _{MS}	ADJLX _{AXL}	ADJLX _{RDL}	LF	OAH	BAR	KG	CICT	MIID
148.00	200.00	12	33	1	820D-200CC12	33.00	1.50	26.00	82.00	104.00	70	3.350	2	CCMT 12 04 08
198.00	250.00	12	33	1	820D-250CC12	33.00	1.50	26.00	82.00	104.00	70	3.670	2	CCMT 12 04 08
248.00	300.00	12	33	1	820D-300CC12	33.00	1.50	26.00	82.00	104.00	70	4.030	2	CCMT 12 04 08

Para obtener más información sobre plaquitas, consulte el Catálogo de herramientas de torneado



- SPMT

KAPR

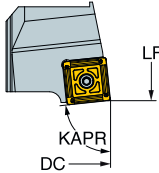

84°

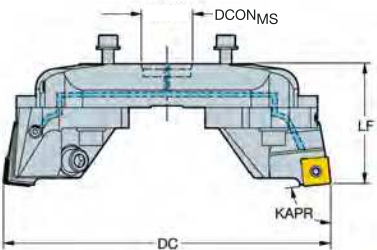
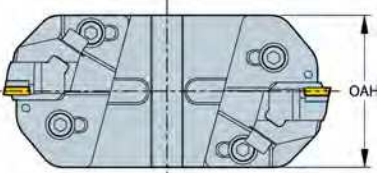

						Dimensiones, mm								
DCN	DCX		CZC _{MS}	CNSC	Código de pedido	DCON _{MS}	ADJLX _{AXL}	ADJLX _{RDL}	LF	OAH	BAR	KG	CICT	MIID
148.00	200.00	12	33	1	820D-200SP12Y	33.00	1.50	26.00	82.00	104.00	70	3.350	2	SPMT 1210-BM
198.00	250.00	12	33	1	820D-250SP12Y	33.00	1.50	26.00	82.00	104.00	70	3.670	2	SPMT 1210-BM
248.00	300.00	12	33	1	820D-300SP12Y	33.00	1.50	26.00	82.00	104.00	70	4.030	2	SPMT 1210-BM

Para obtener información sobre componentes, accesorios y piezas de repuesto para herramientas de mandrinar, visite www.sandvik.coromant.com/es

Estos conjuntos de peso ligero han sido específicamente diseñados para usarse con adaptadores de mandrinado antivibratorios. Los adaptadores antivibratorios se compran por separado, consulte la página K77.



MANDRINADO Mandrinado en desbaste

Herramienta de mandrinado en desbaste CoroBore® 820 XL

Eje - Suministro de refrigerante interior



SPMT

KAPR

90°

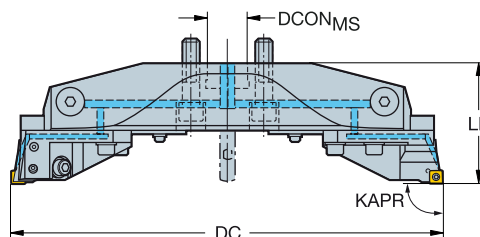
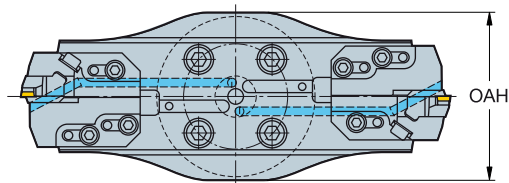
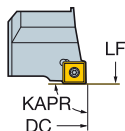

K

Dimensiones, mm

DCN	DCX	CZC _{MS}	CNSC	Código de pedido	DCON _{MS}	ADJL _{AXL}	ADJL _{RDL}	LF	OAH	BAR	KG	CICT	MIID
298.00	380.00	18	40X	820-380SP18	40.00	1.50	41.00	114.00	164.00	70	10.000	2	SPMT 1810-BM
378.00	460.00	18	40X	820-460SP18	40.00	1.50	41.00	119.00	164.00	70	13.131	2	SPMT 1810-BM
458.00	540.00	18	40X	820-540SP18	40.00	1.50	41.00	124.00	164.00	70	16.741	2	SPMT 1810-BM

L



TCMT, TCMX,
TCGT, TCGX
TCEX
TCMW

KAPR

90°

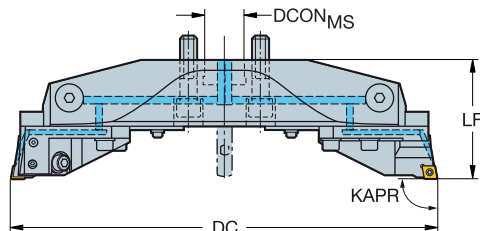
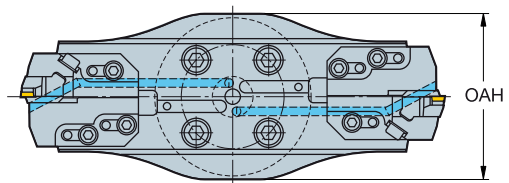
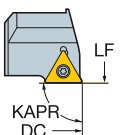

M

Dimensiones, mm

DCN	DCX	CZC _{MS}	CNSC	Código de pedido	DCON _{MS}	ADJL _{AXL}	ADJL _{RDL}	LF	OAH	BAR	KG	CICT	MIID
298.00	380.00	22	40X	820-380TC22	40.00	1.50	41.00	114.00	164.00	70	10.980	2	TCMT 22 04 08
378.00	460.00	22	40X	820-460TC22	40.00	1.50	41.00	119.00	164.00	70	12.720	2	TCMT 22 04 08
458.00	540.00	22	40X	820-540TC22	40.00	1.50	41.00	124.00	164.00	70	16.580	2	TCMT 22 04 08

Utilizar solo con portaherramientas 40X CoroBore XL. Deben pedirse por separado. Consulte la página K76.

En caso de tener la brida directamente en el husillo de la máquina, use un dispositivo de centrado. Consulte la página K77

Para obtener información sobre componentes, accesorios y piezas de repuesto para herramientas de mandrinar, visite www.sandvik.coromant.com/es

Para obtener más información sobre plaquitas, consulte el Catálogo de herramientas de torneado

N



K32



K76



N23



N15



K87

K 28



Herramienta de mandrinado en desbaste CoroBore® 820 XL

Eje - Suministro de refrigerante interior



- CNMM
- CNMG
- CNMA, CNGA

KAPR

90°

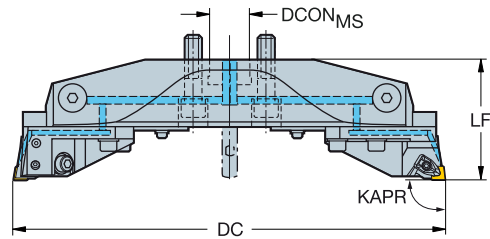
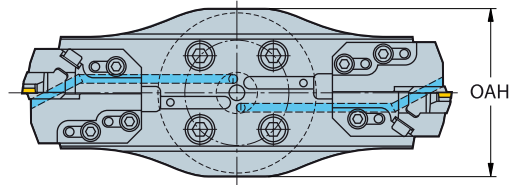
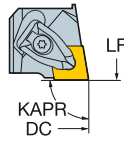

Dimensiones, mm

DCN	DCX	CZC _{MS}	CNSC	Código de pedido	DCON _{MS}	ADJLX _{AXL}	ADJLX _{RDL}	LF	OAH	BAR	KG	CICT	MIID
298.00	380.00	19	40X	820-380CN19	40.00	1.50	41.00	114.00	164.00	70	10.815	2	CNMG 19 06 12
378.00	460.00	19	40X	820-460CN19	40.00	1.50	41.00	119.00	164.00	70	12.685	2	CNMG 19 06 12
458.00	540.00	19	40X	820-540CN19	40.00	1.50	41.00	124.00	164.00	70	16.780	2	CNMG 19 06 12

Para obtener más información sobre plaquitas, consulte el Catálogo de herramientas de torneado



SPMT

KAPR

84°

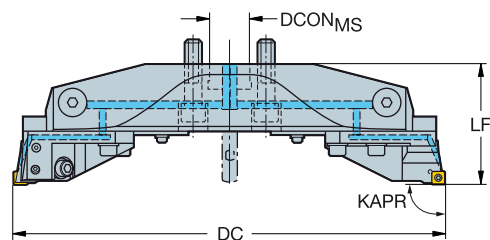
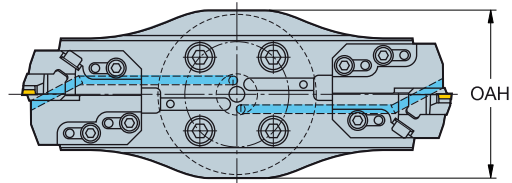
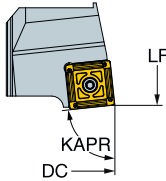

Dimensiones, mm

DCN	DCX	CZC _{MS}	CNSC	Código de pedido	DCON _{MS}	ADJLX _{AXL}	ADJLX _{RDL}	LF	OAH	BAR	KG	CICT	MIID
298.00	380.00	18	40X	820-380SP18Y	40.00	1.50	41.00	114.00	164.00	70	9.050	2	SPMT 1810-BM
378.00	460.00	18	40X	820-460SP18Y	40.00	1.50	41.00	119.00	164.00	70	10.810	2	SPMT 1810-BM
458.00	540.00	18	40X	820-540SP18Y	40.00	1.50	41.00	124.00	164.00	70	12.740	2	SPMT 1810-BM

Utilizar solo con portaherramientas 40X CoroBore XL. Deben pedirse por separado. Consulte la página K76.

En caso de tener la brida directamente en el husillo de la máquina, use un dispositivo de centrado. Consulte la página K77

Para obtener información sobre componentes, accesorios y piezas de repuesto para herramientas de mandrinado, visite www.sandvik.coromant.com/es



MANDRINADO Mandrinado en desbaste

Herramienta de mandrinado en desbaste CoroBore® 820 XL

Eje - Suministro de refrigerante interior
Con extensión de puente



- TCMT, TCMX, TCGT, TCGX, TCEX
- TCMW

KAPR

90°

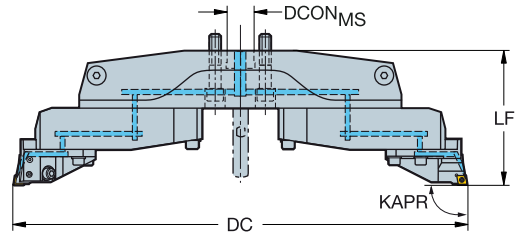
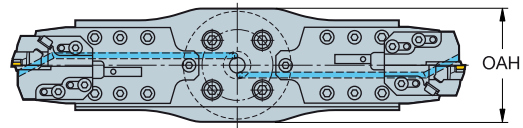
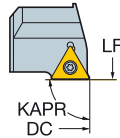

Dimensiones, mm

DCN	DCX		CZC _{MS}	CNSC	Código de pedido	DCON _{MS}	ADJLX _{AXL}	ADJLX _{RDL}	LF	OAH	BAR	KG	CICT	MIID
538.00	780.00	22	40X	1	820-780TC22	40.00	1.50	121.00	198.00	164.00	70	28.000	2	TCMT 22 04 08
778.00	1020.00	22	40X	1	820-1020TC22	40.00	1.50	121.00	218.00	164.00	70	48.000	2	TCMT 22 04 08
1018.00	1260.00	22	40X	1	820-1260TC22	40.00	1.50	121.00	218.00	164.00	70	43.730	2	TCMT 22 04 08

Para obtener más información sobre plaquitas, consulte el Catálogo de herramientas de torneado

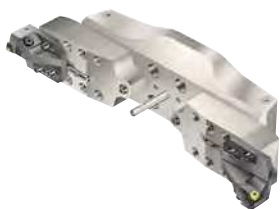

SPMT

KAPR

84°

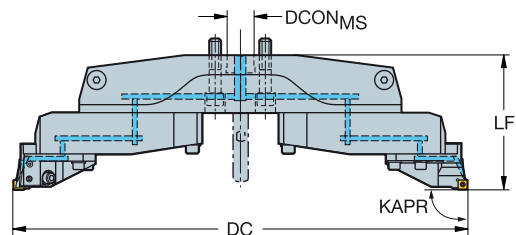
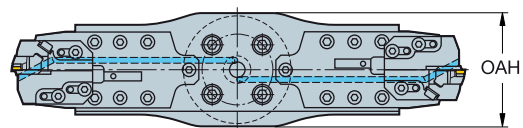
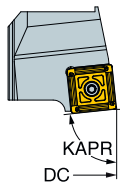

Dimensiones, mm

DCN	DCX		CZC _{MS}	CNSC	Código de pedido	DCON _{MS}	ADJLX _{AXL}	ADJLX _{RDL}	LF	OAH	BAR	KG	CICT	MIID
538.00	780.00	18	40X	1	820-780SP18Y	40.00	1.50	121.00	198.00	164.00	70	25.190	2	SPMT 1810-BM
778.00	1020.00	18	40X	1	820-1020SP18Y	40.00	1.50	121.00	218.00	164.00	70	36.380	2	SPMT 1810-BM
1018.00	1260.00	18	40X	1	820-1260SP18Y	40.00	1.50	121.00	218.00	164.00	70	43.810	2	SPMT 1810-BM

Utilizar solo con portaherramientas 40X CoroBore XL. Deben pedirse por separado. Consulte la página K76.

En caso de tener la brida directamente en el husillo de la máquina, use un dispositivo de centrado. Consulte la página K77

Para obtener información sobre componentes, accesorios y piezas de repuesto para herramientas de mandrinado, visite www.sandvik.coromant.com/es



K32



K76



N23



N15



K87

K 30



Herramienta de mandrinado en desbaste CoroBore® 820 XL

Eje - Suministro de refrigerante interior
Con extensión de puente

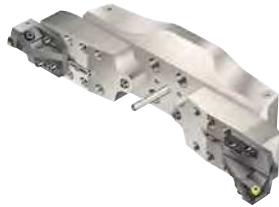

KAPR

90°

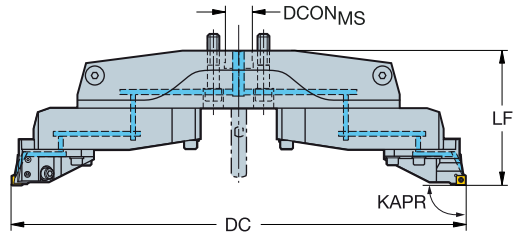
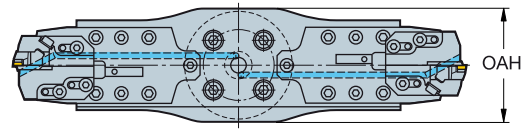
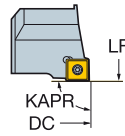

Dimensiones, mm

DCN	DCX	CZC _{MS}	CNSC	Código de pedido	DCON _{MS}	ADJLX _{AVL}	ADJLX _{RDL}	LF	OAH	BAR	KG	CICT	MIID
538.00	780.00	18	40X	820-780SP18	40.00	1.50	121.00	198.00	164.00	70	39.000	2	SPMT 1810-BM
778.00	1020.00	18	40X	820-1020SP18	40.00	1.50	121.00	218.00	164.00	70	36.380	2	SPMT 1810-BM
1018.00	1260.00	18	40X	820-1260SP18	40.00	1.50	121.00	218.00	164.00	70	43.810	2	SPMT 1810-BM



CNMM
CNMG
CNMA, CNGA

KAPR

90°

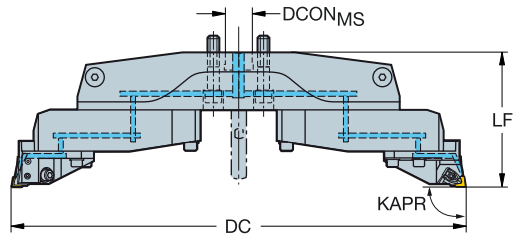
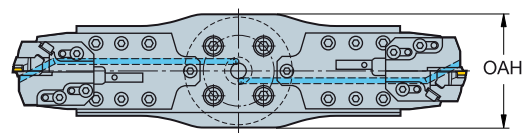
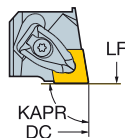

Dimensiones, mm

DCN	DCX	CZC _{MS}	CNSC	Código de pedido	DCON _{MS}	ADJLX _{AVL}	ADJLX _{RDL}	LF	OAH	BAR	KG	CICT	MIID
538.00	780.00	19	40X	820-780CN19	40.00	1.50	121.00	198.00	164.00	70	34.000	2	CNMG 19 06 12
778.00	1020.00	19	40X	820-1020CN19	40.00	1.50	121.00	218.00	164.00	70	43.000	2	CNMG 19 06 12
1018.00	1260.00	19	40X	820-1260CN19	40.00	1.50	121.00	218.00	164.00	70	43.830	2	CNMG 19 06 12

Utilizar solo con portaherramientas 40X CoroBore XL. Deben pedirse por separado. Consulte la página K76.

En caso de tener la brida directamente en el husillo de la máquina, use un dispositivo de centrado. Consulte la página K77

Para obtener información sobre componentes, accesorios y piezas de repuesto para herramientas de mandrinar, visite www.sandvik.coromant.com/es

Para obtener más información sobre plaquitas, consulte el Catálogo de herramientas de torneado



K32



K76



N23



N15



K87



MANDRINADO Mandrinado en desbaste

Plaquitas CoroBore® 111 para mandrinado en desbaste

Plaquita tipo S (Cuadrada)

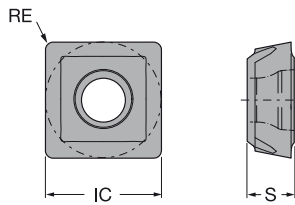

		IC	S	RE	CÓDIGO ISO	P	M	K	S	
						4325	2025	3210	1145	
Medio	BM	06	6.0	2.60	0.60	SPMT0606-BM	☆	☆	☆	☆
		08	8.9	3.00	0.80	SPMT0808-BM	☆	☆	☆	☆
		12	12.65	4.00	1.00	SPMT1210-BM	☆	☆	☆	☆
		18	18.6	5.50	1.00	SPMT1810-BM	☆	☆	☆	☆
Desbaste	BR	06	6.0	2.60	0.60	SPMT0606-BR	☆	☆	☆	☆
		08	8.9	3.00	0.80	SPMT0808-BR	☆	☆	☆	☆
		12	12.65	4.00	1.20	SPMT1212-BR	☆	☆	☆	☆
		18	18.6	5.50	1.20	SPMT1812-BR	☆	☆	☆	☆



K91



N23

K 32



Cartucho para CoroBore® XL

KAPR 84°



SPMT

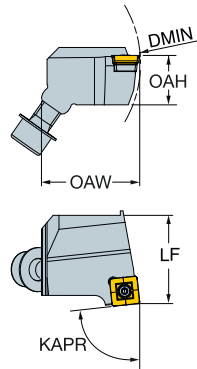

Dimensiones, mm		Dimensiones, mm									
DMIN ₁	CZC _{MS}	Código de pedido	LF	HF	WF	OAH	OAL	KG	CICT	MIID	
148.0	12	S12 S12-R820XLR40SSYP12	40.00	22.40	42.00	30.16	43.30	0.250	1	SPMT 1210-BM	

KAPR 84°

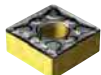

SNMM
SNMG
SNMA, SNGA

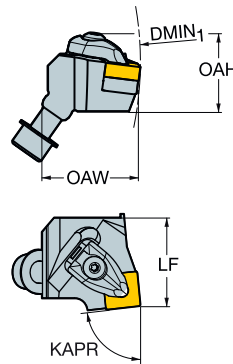

Dimensiones, mm		Dimensiones, mm									
DMIN ₁	CZC _{MS}	Código de pedido	LF	LPR	HF	WF	OAH	OAL	KG	CICT	MIID
148.0	15	S12 S12-R820XLR40DSYN15	40.00	41.80	20.00	42.00	39.70	43.80	0.310	1	SNMG 15 06 08

Para obtener más información sobre plaquitas, consulte el Catálogo de herramientas de torneado
Para obtener información sobre piezas de repuesto, visite www.sandvik.coromant.com/es

